



Agilent 7000C and 7010 Triple Quadrupole GC/MS Systems

RESOLVE YOUR SEARCH FOR ACCURACY

The Measure of Confidence



Agilent Technologies

RESOLVE YOUR SEARCH FOR PRECISION, RELIABILITY, AND THE LOWEST DETECTION LIMITS

The advanced Agilent 7000C and 7010 Triple Quadrupole GC/MS systems provide everything you need to take your lab to a higher plane of productivity and confidence – including low detection limits, robustness, and software tools that simplify method optimization and lower your operating costs. They also integrate seamlessly with the Agilent 7890B GC.

What's more, every 7000C and 7010 system conforms to strict quality standards, so you can be sure you're getting the most reliable data – both today and in the future.

The 7000C and 7010 Triple Quadrupole GC/MS systems are part of the industry's broadest, most feature-rich portfolio of GC and GC/MS systems and software.

- Best MS sensitivity
- Efficient and flexible MRM optimization
- Eco-friendly resource management



Agilent 5977E GC/MSD



Agilent 5975T LTM
GC/MSD



Agilent 5977A GC/MSD



Agilent 7200B Q-TOF GC/MS

MS/MS Selectivity

The 7000C and 7010 Triple Quadrupole GC/MS systems were designed to achieve confident trace detection in complex matrices. MS/MS continues to replace SIM based applications by reaching lower detection levels and reliable identification while reducing the need for re-analysis in challenging matrices.

Stability and robustness: the keys to your productivity

From inert inlet to inert source, Agilent's commitment to quality throughout the design and manufacturing process means you can count on every GC/MS system we build.

Integrated intelligence

Early maintenance feedback alerts you to problems before they happen, reducing costly downtime.

Useful sensitivity

Increased sensitivity in the Agilent 7010 GC/MS/MS can help users achieve lower detection limits, inject smaller volumes, extract smaller sample sizes, and spend less time in sample prep.

Eco-friendly GC/MS



Integrated **Sleep/Wake modes** reduce gas and energy usage. You can also switch to lower-cost gases while in standby mode.

The best GC/MS systems and software features ensure successful day-to-day measurements



Smart technology aligns GC and MS operation

The Agilent 7890B GC – with its efficient protocols and fully synchronized MS operation – is a dynamic partner for Agilent Triple Quadrupole GC/MS systems. **Page 4**

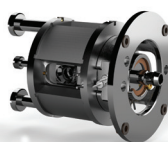

The most sensitive and accurate Triple Quadrupole GC/MS systems

Including the all-new High Efficiency EI Source—plus the only quadrupole operating at up to 200 °C—the Agilent 7010 Triple Quadrupole GC/MS system consistently delivers stable, superior performance.

Page 6 - 7

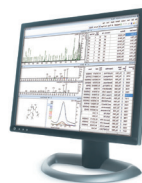

Integrated software tools simplify method development

From instrument settings to data analysis and reporting, MassHunter puts you in control – and makes MS/MS analysis routine when combined with our Pesticides and Environmental Pollutants MRM Database. **Page 8**



Analyzers for guaranteed chromatographic performance

The exceptional performance of the Triple Quadrupole GC/MS systems is validated by data from common food safety, environmental, and toxicology methods.

Page 12



Complete inert pathway

Maintain sample integrity – while reducing analyte loss and decomposition – from carrier gas introduction through detector. **Page 17**



Easy method development

Agilent Analyzers let you start generating quality data immediately after installation. **Page 19**

To learn more about Agilent Triple Quadrupole GC/MS systems, visit agilent.com/chem/ms

RESOLVE YOUR SEARCH FOR RELIABILITY WITH THE NEXT EVOLUTIONARY STEP IN GC

Now, we have achieved a new level of productivity and GC/MS integration with the Agilent 7890B GC.

Building the world's most trusted GC system is an ongoing process. With every step, we improve performance, increase speed, and develop new analytical capabilities – all while never losing sight of *results*.

Agilent's flagship 7890B GC system has everything you need to generate data with confidence, while processing more samples in less time at the lowest possible cost. Its precise pneumatics and oven temperature control, combined with our versatile Multimode Inlet (MMI) and inert Split/Splitless inlet, deliver results you expect from the market-leading GC.

Backflush, supported by Capillary Flow Technologies, enhances performance, productivity, and reliability

Advantages include:

- Best MS sensitivity
- Shorter analysis times
- Longer column life
- Extended maintenance-free operation
- Backflush EPC included

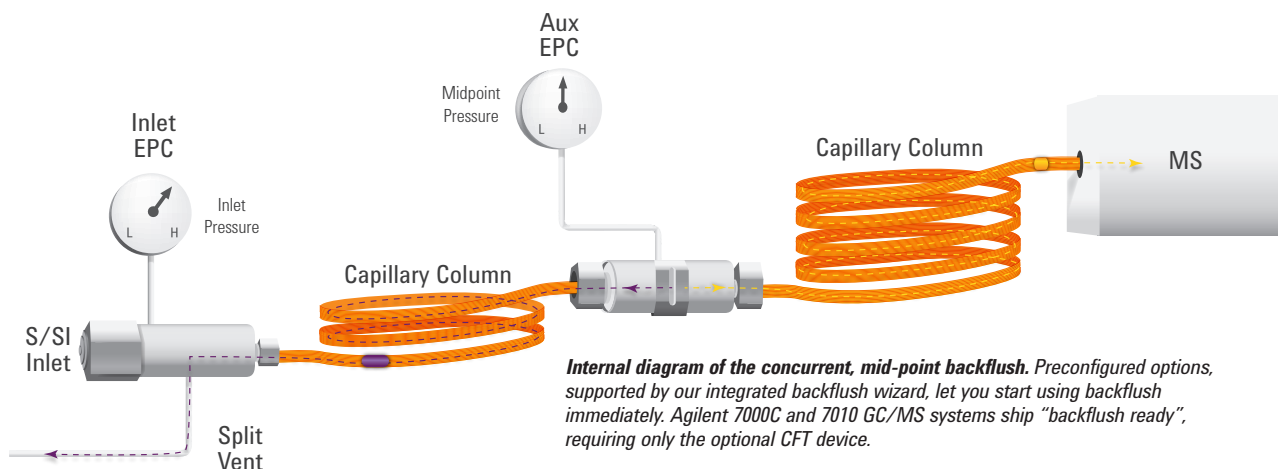

INTEGRATED INTELLIGENCE BOOSTS PRODUCTIVITY

Quickly find and order the Agilent parts you need

Our **integrated Parts Finder** helps you locate key parts for your Agilent Triple Quadrupole GC/MS. You can even build shopping lists that let you order directly from the Agilent website.

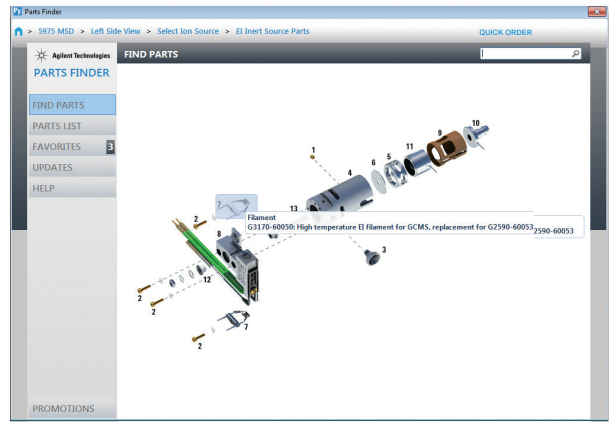
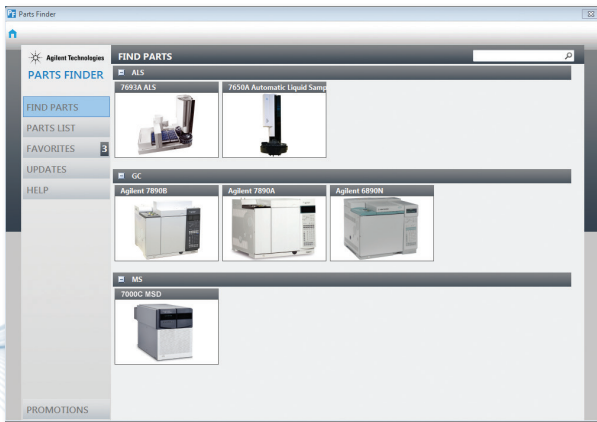

Conserve valuable resources

Sleep mode saves energy and gas – and protects your investment by cooling heated zones.

Wake mode prepares your system for use *before* the start of your next workday.

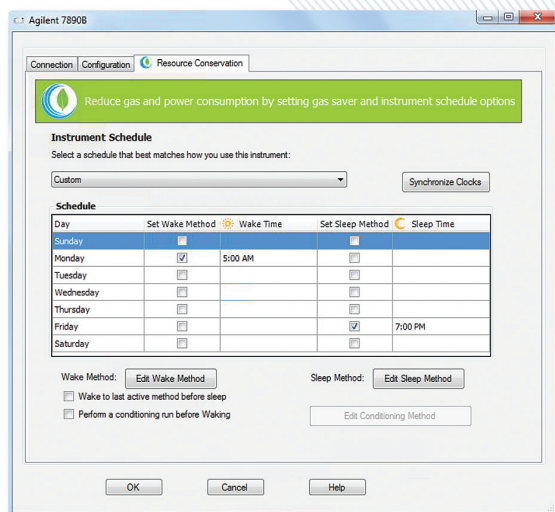

Simplify method setup and system operation

Integrated **GC calculators** automatically update optimal parameters, simplifying method development and implementation.

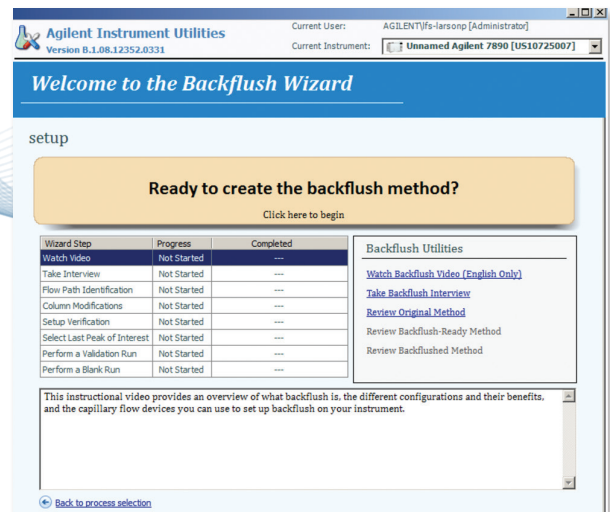

RELIABLE QUANTITATIVE AND QUALITATIVE RESULTS – EVEN AT LOW FEMTOGRAM LEVELS

The key to accuracy: Instrument Detection Limits (IDL)

You can be confident in your results from *day one*, because we demonstrate the Automatic Liquid Sampler (ALS), GC, and MS performance of every Agilent Triple Quadrupole GC/MS at installation in your laboratory. This ensures industry-leading precision, accuracy, and detection limits that satisfy your most demanding analytical requirements.

For more information about IDL, see publication 5990-9436EN.

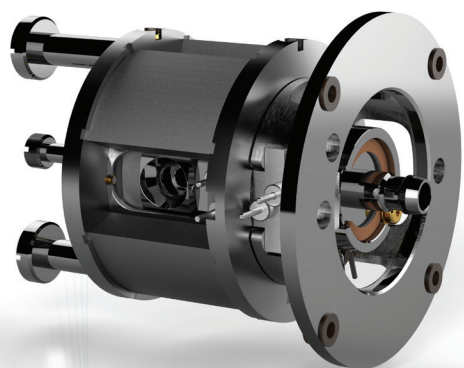

Attogram detection limits from an EI source

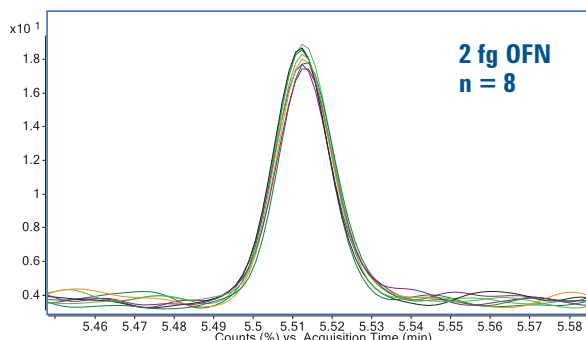

Analysis of octafluoronaphthalene (2 fg)

LOD = 300 attograms (calculated from 8 consecutive injections)

7010: IDL <= 0.5 fg OFN (2 fg injected)

7000C: IDL <= 4 fg OFN (10 fg injected)

Demonstrated at installation.

Positive MS/MS identification based on exact area counts

Reliable compound identification (like accurate quantitation) depends on the accuracy and precision of the qualifier ions' area counts. The exceptional ion ratio stability of both triple quadrupole systems allows you to positively identify compounds, even at trace concentrations, while eliminating false negatives.

Concentration	0.02 ppb	0.1 ppb	1 ppb	10 pp b	100 ppb
Ion Ratios at Multiple Injections	35.4	50.8	53.8	55.6	56.5
	40.4	49.9	57.0	55.9	56.4
	36.5	48.2	55.9	55.6	56.7
	36.6	49.9	55.6	55.8	57.3
	28.2	47.6	53.7	55.7	56.7
% RSD Ion Ratios	13%	3%	2.6%	0.23%	0.62%

% RSDs of dichlobenil ion ratios in fruit extract. Dichlobenil – as part of a 100+ compound pesticide screen – was injected 5 times at different concentrations, using transitions 173→100 and 171→136. An RSD of 1% or less was achieved at concentrations of 10 ppb and above. Even at 0.5 ppb level the RSD was 10% – well below the commonly accepted 20% limit. Ratios seen are rounded to 2 digits. RSDs based on unrounded values.

THE GOLD STANDARD OF PERFORMANCE

All-new high-efficiency EI or PCI/NCI ion source with uniform thermal profile

Maximizes the number of ions that are successfully transferred out of the ion source body and into the quad analyzer.

Triple-Axis Detector

Drastically reduces neutral noise, ensuring a cleaner signal and lower detection limits.

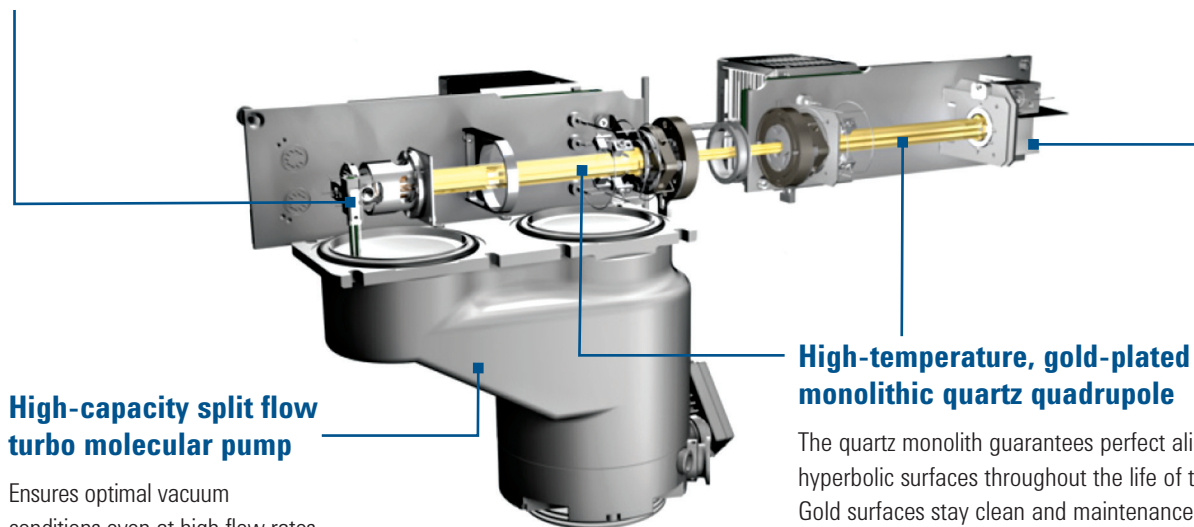

High-capacity split flow turbo molecular pump

Ensures optimal vacuum conditions even at high flow rates.

High-temperature, gold-plated monolithic quartz quadrupole

The quartz monolith guarantees perfect alignment for hyperbolic surfaces throughout the life of the MS. Gold surfaces stay clean and maintenance free in high temperatures – up to 200 °C.

Minimize cost and productivity pitfalls with the Helium Conservation Module to reduce – or Hydrogen Sensor to eliminate – helium use.

Automatically conserve helium during standby

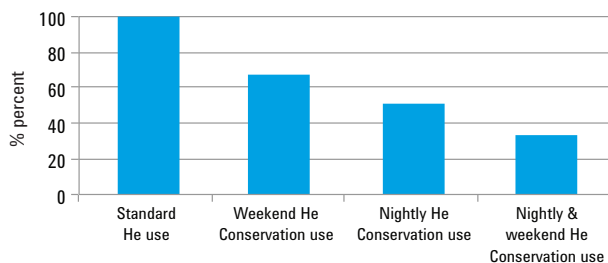

Reduce He usage by as much as 65% while maintaining an inert helium environment in the MS.

Switch to hydrogen carrier gas

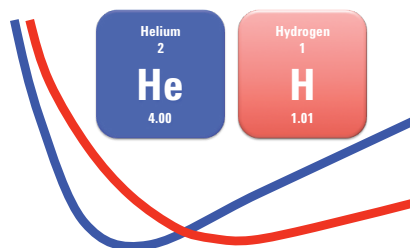

The 7890B/7000C is hydrogen ready. And Agilent can help you make a successful transition with the Hydrogen Sensor, fully integrated into the 7890B GC.

BUILD LARGE, OPTIMIZED MULTIPLE REACTION MONITORING (MRM) METHODS QUICKLY AND CONFIDENTLY

The Pesticides and Environmental Pollutants (P&EP) MRM Database, a key tool in developing acquisition methods, has up to eight MRM transitions with relative intensities for each compound. The ability to provide multiple MRM transitions allows the operator to choose transitions that minimize matrix interferences.

Manually creating an MRM and quantification method for a long list of compounds is a tedious process and can introduce transcription error to the analysis. The graphical user interface (GUI) makes development of these methods more efficient and saves significant amount of time. See publication *5991-4419EN The Pesticides and Environmental Pollutants (P&EP) GC/MS/MS 3.0 Analyzer*

The most extensive, comprehensive database

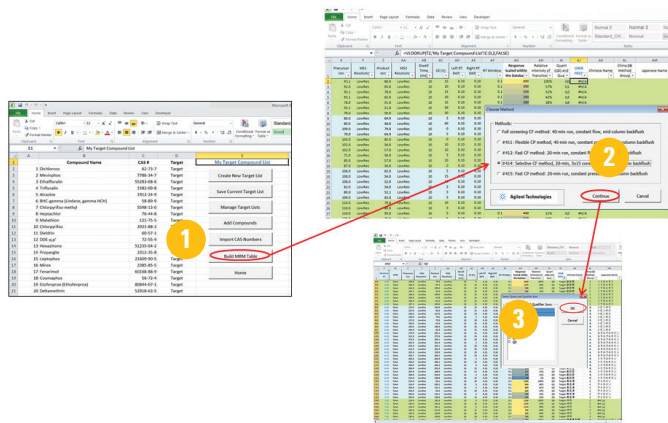

MRM transitions are chosen in a 3-step process:

- 1 Select "Build MRM Table".
- 2 Choose desired method.
- 3 Choose quant and qualifier ions.

Value of multiple optimized transitions in the MRM Database: Not just to avoid matrix interferences but also for additional confirmation.

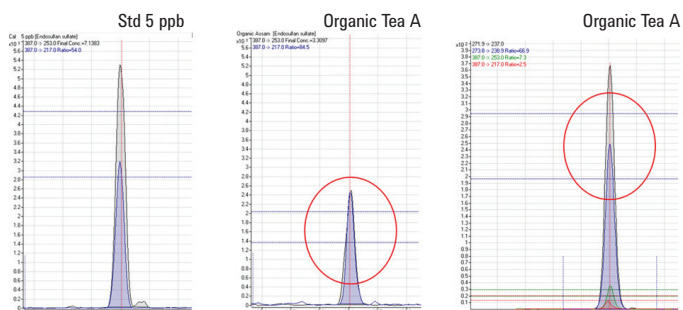

Target standard: Ion ratio within confidence band

Target in sample: Ion ratio outside confidence band

Target in sample: Ion ratio within confidence band

Analysis of pesticides in tea. The first transition shown fell outside the 80-120% confidence band; endosulfan sulfate could not be confirmed. After choosing to use other transitions available in the MRM Database, the qualifying transitions fell inside the 80–120% confidence band providing confirmation of endosulfan sulfate in the tea sample.

MASSHUNTER SOFTWARE:

SEAMLESS AUTOMATION WITH DETAILS YOU CUSTOMIZE

MassHunter MRM optimization software automatically generates the most favorable sequence of transitions to impart optimal detection conditions. If called upon, it even allows for automatic adjustment of the dwell time to compensate for specific response differences or detection level requirements.

Time segments							
	Time	Scan type	Electron energy	Delta EMV	Calculated EMV	Gain	Data stored
	11	9.46	MRM		1594.0	10	<input checked="" type="checkbox"/>
	12	9.73	MRM		1594.0	10	<input checked="" type="checkbox"/>
	13	10.17	MRM		1594.0	10	<input checked="" type="checkbox"/>
	14	10.52	MRM		1594.0	10	<input checked="" type="checkbox"/>
	15	10.76	MRM		1594.0	10	<input checked="" type="checkbox"/>
	16						

Scan segments								
	Compound name	ISTD?	Precursor ion	MS1 resolution	Product ion	MS2 resolution	Dwell	Collision energy
	Chlordane, trans-	<input type="checkbox"/>	372.8	Wide	265.8	Wide	27.2	25
	Chlordane, trans-	<input type="checkbox"/>	372.8	Wide	263.8	Wide	27.2	25
	Fipronil	<input type="checkbox"/>	366.9	Wide	254.9	Wide	27.2	15
	Fipronil	<input type="checkbox"/>	366.9	Wide	212.9	Wide	27.2	20
	Captan	<input type="checkbox"/>	151	Wide	80	Wide	81.7	3
	Captan	<input type="checkbox"/>	149	Wide	79	Wide	81.7	10
	Allethrin	<input type="checkbox"/>	123	Wide	81	Wide	27.2	10
	Allethrin	<input type="checkbox"/>	123	Wide	43	Wide	27.2	15

To enhance the response of captan, a difficult analyte, longer dwell times were assigned automatically based on the operator's input.

MassHunter Data Analysis and reporting provides a unified platform for all Agilent MS products – and puts the latest MS tools to work in your laboratory.

Batch Table											
Sample	Data File	Type	Level	RT	Accuracy	Calc. Conc.	Ratio	RT	Accuracy	Calc. Conc.	Ratio
pest-0.1ppm.D	Cal	3	4.195	144.0	0.1440	16.5	4.704	265.3	0.2653	289.3	5.052
pest-0.2ppm.D	Cal	4	4.190	116.3	0.2326	14.4	4.704	158.8	0.3176	209.3	5.052
pest-0.5ppm.D	Cal	5	4.195	99.3	0.4964	15.4	4.704	144.0	0.4929	211.1	5.057
pest-1.0ppm.D	Cal	6	4.190	90.4	0.9040	15.9	4.704	83.6	0.9356	210.0	5.052
pest-2.0ppm.D	Cal	7	4.190	95.0	1.8995	16.5	4.704	87.6	1.7513	191.1	5.052
pest-5.0ppm.D	Cal	8	4.190	99.3	4.9626	15.6	4.704	95.4	4.7686	183.6	5.057
pest-10ppm.D	Cal	9	4.191	100.8	10.0784	15.7	4.704	97.5	9.7478	181.1	5.057
pest-20ppm.D	Cal	10	4.190	99.9	19.9843	16.1	4.708	101.1	20.2151	176.5	5.057

Easy visualization of quantitative results: customize how you use and view quality outliers, integration data, calibration curves, and results.

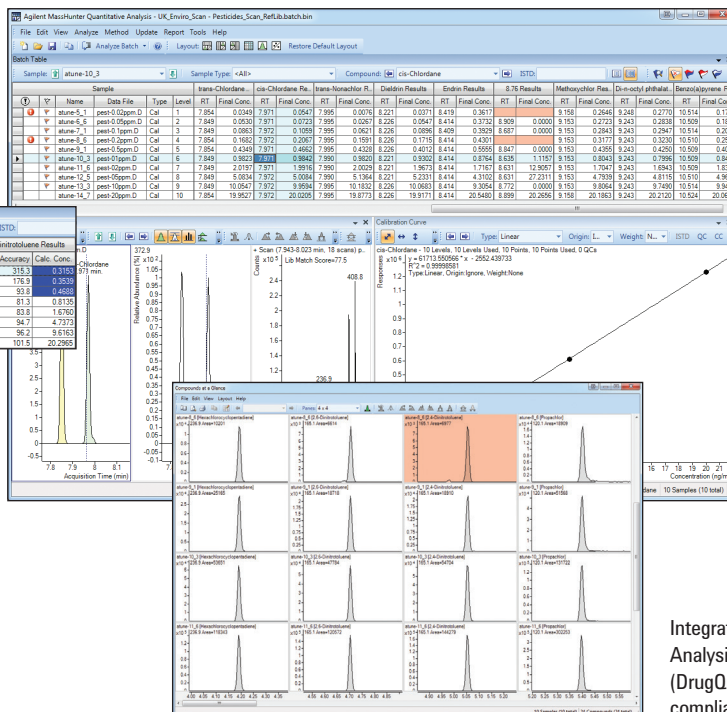

Improve the quality and speed of your data review with automated metrics and Unified Data Analysis for Agilent MS systems.

Integrated Drug Confirmation Analysis workflow (DrugQuant) facilitates compliance.

WORK SMARTER WITH INTEGRATED GC, MS, AND SOFTWARE TECHNOLOGIES

Integrated GC/MS communication and safety controls

- Direct communication between GC and MS helps detect faults – protecting both instruments.
- Designed for hydrogen carrier gas, so you can switch from helium to less expensive carrier gases for faster analysis and greater chromatographic resolution.

Automated Self-Cleaning Ion Source*

- Reduces contamination build-up and keeps the source operational.
- Maintains performance, saves time, and increases productivity.

* Available on select PAH applications. Contact us at agilent.com/chem/contactus or call 800-227-9770 (in the U.S. or Canada) for other available configurations that feature the Self-Cleaning Ion Source.

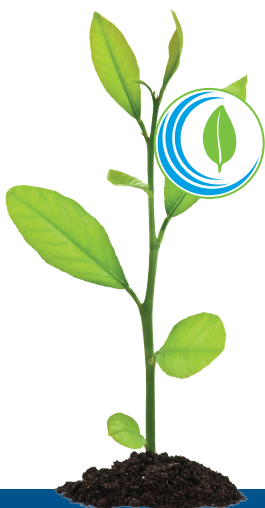

Eco-friendly operation

- Sleep/Wake modes can easily be set to suit your schedule.
- Conserves energy and carrier gas.

Long-term reliability and performance

- Modular analyzer design simplifies routine maintenance.
- Early Maintenance Feedback (EMF) alerts you to minor problems before they lead to a major breakdown.

Early Maintenance Feedback

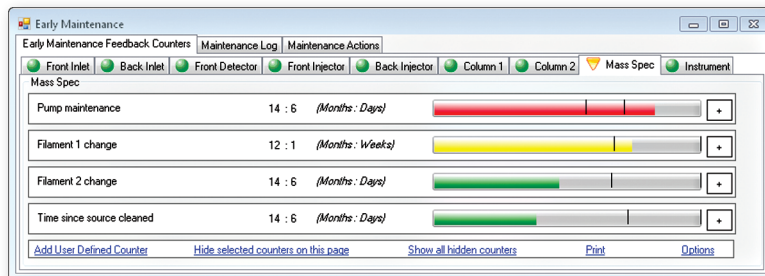

The industry's best software platform

- MassHunter lets you optimize your workflow to generate answers quickly and confidently.
- Built-in GC calculators and translators reduce method development time.
- Parts Finder tool quickly identifies parts and part numbers for easy re-ordering.

Higher productivity and lower cost of operation

- Quick Vent lets you spend less time on maintenance, and more time running samples.
- Backflush Wizard makes backflush optimization fast and easy.



To learn more about the Agilent 7000C and 7010 Triple Quadrupole GC/MS Systems, visit agilent.com/chem/7000C and agilent.com/chem/7010

PESTICIDES IN FOOD

PROTECT THE QUALITY AND SAFETY OF OUR FOOD SUPPLY

Worldwide food demands have increased the use of pesticides, therefore the global food supply chain needs to be carefully monitored to ensure pesticide residues do not pose a risk to human health – particularly to children. This puts you under pressure to lower detection limits, decrease analysis time, and support timely distribution of fruits and vegetables.

The 7000C and 7010 Triple Quadrupole GC/MS systems together with Agilent sample preparation supplies, enable sensitive, selective, and robust techniques for measuring pesticide residues in foods. In addition, our Pesticides and Environmental Pollutants MRM Database offers extensive resources to minimize matrix interferences and facilitate your accurate identification and quantification of targets.



From sample preparation to GC optimization to MS/MS transition selection, Agilent can help you optimize every step of your analysis.

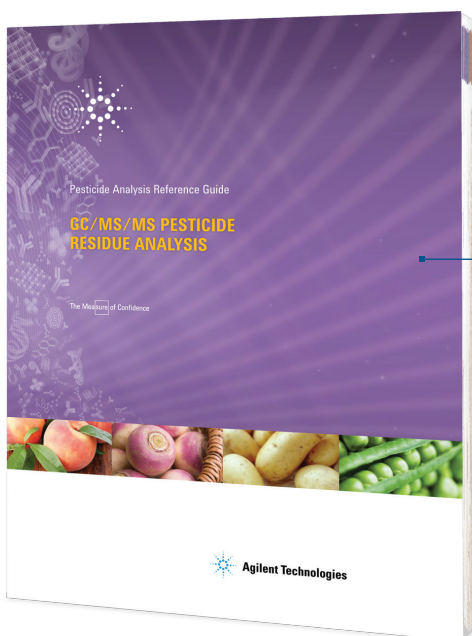

Lower Detection Limits

More Analytes Identified

Simpler Sample Preparation

Greater Matrix Variation

Reduced Analysis Time

Tighter QC Criteria

Higher Throughput

To request your copy of the Pesticides Analysis Reference Guide, contact your Agilent Representative at agilent.com/chem/contactus

Routine analysis, outstanding results

- Reliable analysis of a wide range of commodities and pesticides
- Low detection levels, down to sub-ppb
- Remarkable stability – even at low levels – proven by accurate area reproducibility, stable ion ratios, and accurate recoveries
- Wide calibration ranges
- Retention time locking (RTL) and column backflush
- Low maintenance: less frequent analyzer cleaning, fewer column changes, and easy replacement of inlet liners

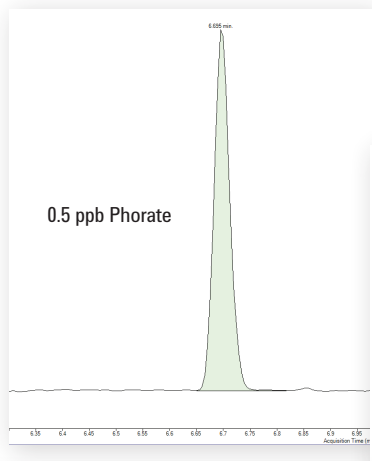

Phorate quant ion plots at 0.5 and 0.1 ppb in plum matrix as part of a 100+ analyte screen.

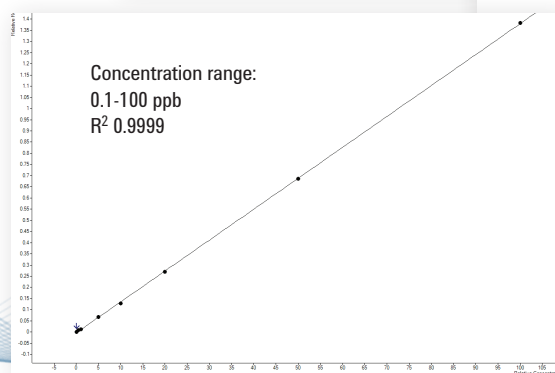
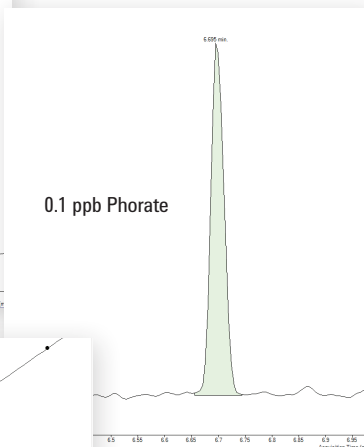

Calibration plot of Phorate in matrix using the Agilent 7000C GC/MS. R^2 value in the 0.1-100 ppb range was 0.9999.

The lowest detection limits for the most challenging analyses

Dioxin and dioxin-like PCBs are considered among the most toxic compounds in existence. Whether you are using a triple quadrupole GC/MS system for screening or for confirmation of food and feed samples (as now allowed by EU regulations 589/2014 and 709/2014), you'll want the most sensitive system available – the Agilent 7010.

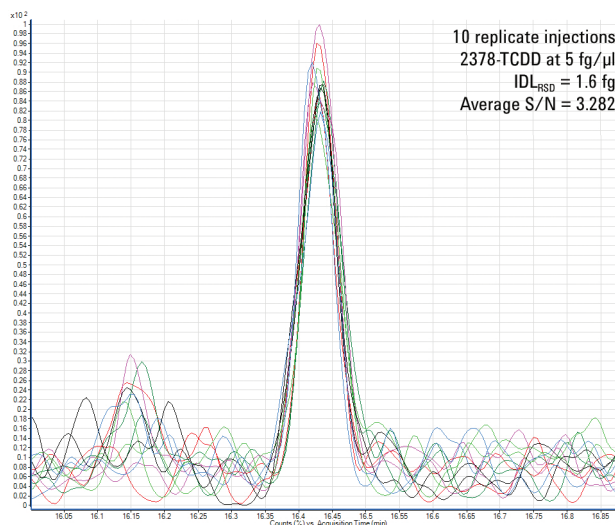

Excellent repeatability and femtogram-level sensitivity.

PAH ANALYSIS IN ENVIRONMENTAL SAMPLES

PERFORM HIGHLY SENSITIVE, MULTIRESIDUE TARGET ANALYSIS

Concern about the bioaccumulation and genotoxicity of polycyclic aromatic hydrocarbons (PAHs) and other persistent organic contaminants is driving the demand for rapid, reliable identification of chemical residues.

To complicate matters, the list of PAHs studied has grown and those with high toxic equivalency (TEQ) values, such as benzo(a)pyrene, must be monitored at much lower levels.

With its unmatched detection limits, peak symmetry, linearity, ion ratio stability, and accuracy for both native and labeled analogs, an Agilent Triple Quadrupole GC/MS can help you meet these challenges.

And to top it all off, the ion source does not need cleaning.

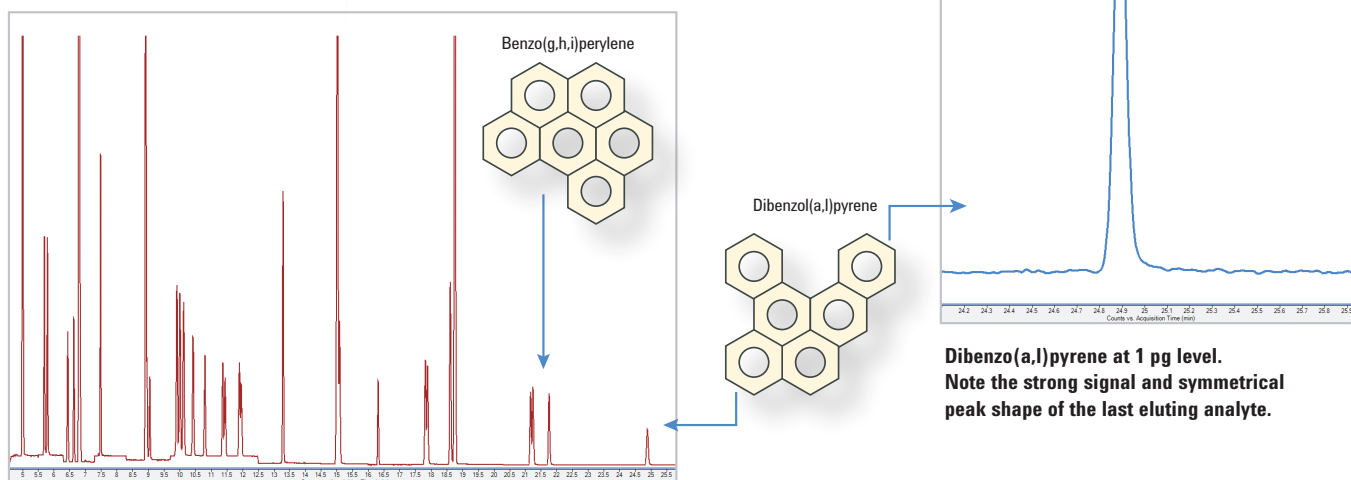

Dibenzo(a,l)pyrene at 1 pg level.
Note the strong signal and symmetrical peak shape of the last eluting analyte.

TIC Chromatogram of 28 PAH and 5 deuterated IS using the 7000C Triple Quadrupole GC/MS with Self-Cleaning Ion Source. Analyte concentration is 50 pg.

Analyte conc. (pg/ μ L)	Dibenzo(a,l)pyrene			Perylene-d12, IS at 500 pg, all levels		
	RRF Q1	RRF Q2	Ion Ratio Q1/Q2	Area Q1	Area Q2	Ion Ratio Q1/Q2
1	6.13	0.83	1.42	221364	21054	10.5
5	6.34	0.84	1.39	229847	21903	10.5
10	6.27	0.82	1.38	227708	21561	10.6
50	6.37	0.84	1.38	226981	21573	10.5
100	6.28	0.81	1.37	225185	21388	10.5
500	6.24	0.81	1.37	231002	21865	10.6
1000	5.97	0.78	1.38	216076	20393	10.6
%RSD	2.2%	2.5%	1.4%	2.3%	2.5%	0.3%

Linearity of native analytes in the range of 1 pg to 1 ng, resulting in $\leq 3\%$ RSD for the Relative Response Factors (RRF). Exceptionally stable ion ratios of 1.4% (analyte) and 0.3% (IS) were achieved, with unrivaled precision of the deuterated internal standard areas. The IS area RSD was less than 3%, while the coeluting native concentration changed by 1000 fold. The R^2 value was 0.9998 in this range.

How does Agilent's unique Self-Cleaning Ion Source boost your productivity?

During prolonged GC/MS use, matrix contamination and column bleed can interfere with precise trace-level measurements.

Fixing this problem typically requires you to interrupt your analysis and clean the ion source. But now, the patented **Self-Cleaning Ion Source** option on Agilent Triple Quadrupole GC/MS systems greatly reduces or eliminates the need for source cleaning – simplifying maintenance and enhancing your productivity.

Other benefits include:

- No waiting for the system to cool down before accessing the ion source
- No source assembling or disassembling
- No scrubbing of the lenses (or other components)
- No retuning
- No recalibrating

Two operational modes are available: continuous cleaning, and cleaning between runs while the system is equilibrating.

Now available with the PAH analyzer.

Contact us at agilent.com/chem/contactus or call 800-227-9770 (in the U.S. or Canada) for other available configurations that feature the Self-Cleaning Ion Source.

No more disassembling!

The Self-Cleaning Ion Source delivers *in-situ* cleaning, so you rarely need to touch the source.



PERSISTENT ORGANIC POLLUTANTS (POPS) IN SERUM

SENSITIVITY SUFFICIENT FOR THE LOWEST EXPOSURE LEVELS

Measurement of POPs in infant serum samples is one of the most challenging scenarios imaginable: levels 1000X lower than most food and drug metabolites, and very little sample volume to work with.

With its high-efficiency EI source, the Agilent 7010 Triple Quadrupole GC/MS system opens new frontiers in the understanding of chemical exposure and human health.

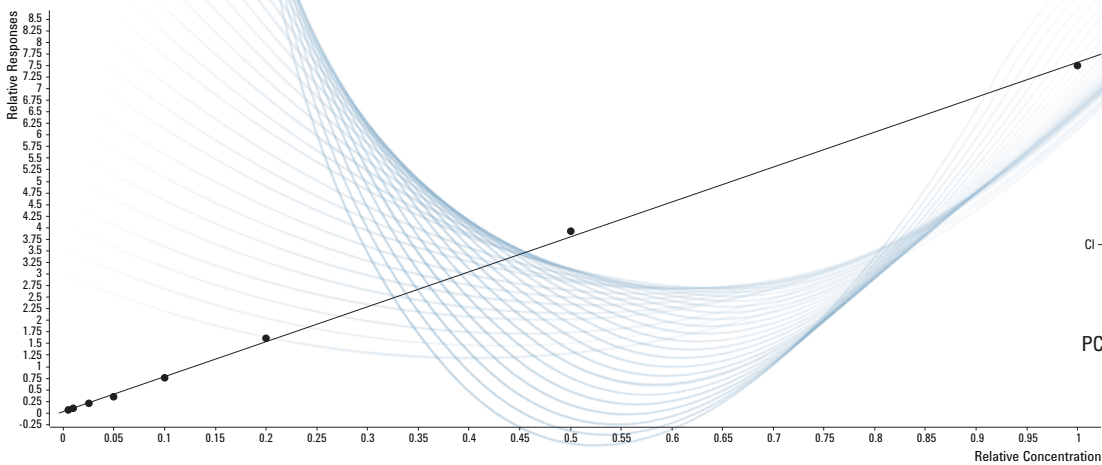
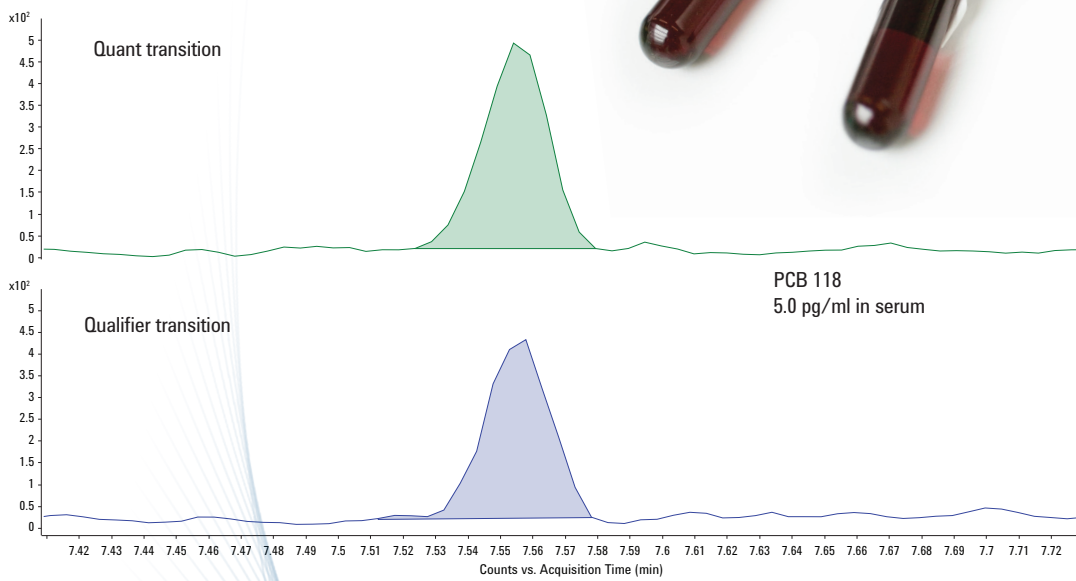

PCB 118 calibration curve from 0.005 to 1.0 ng/ml

ENSURING AN INERT FLOW PATH HAS NEVER BEEN MORE CRITICAL



Lower detection levels, simpler sample preparation, and more chemically active sample extracts are the norm for today's trace-level analysis. That means you cannot afford losses caused by flow path activity. For starters, having to repeat or verify suspect analyses wastes valuable resources, hinders productivity, and hurts your bottom line. And with minute amounts of sample, you might not even *get* a second chance, because there may be no more sample left to analyze.

Agilent's Inert Flow Path allows your samples to pass safely from injector to detector

Sample

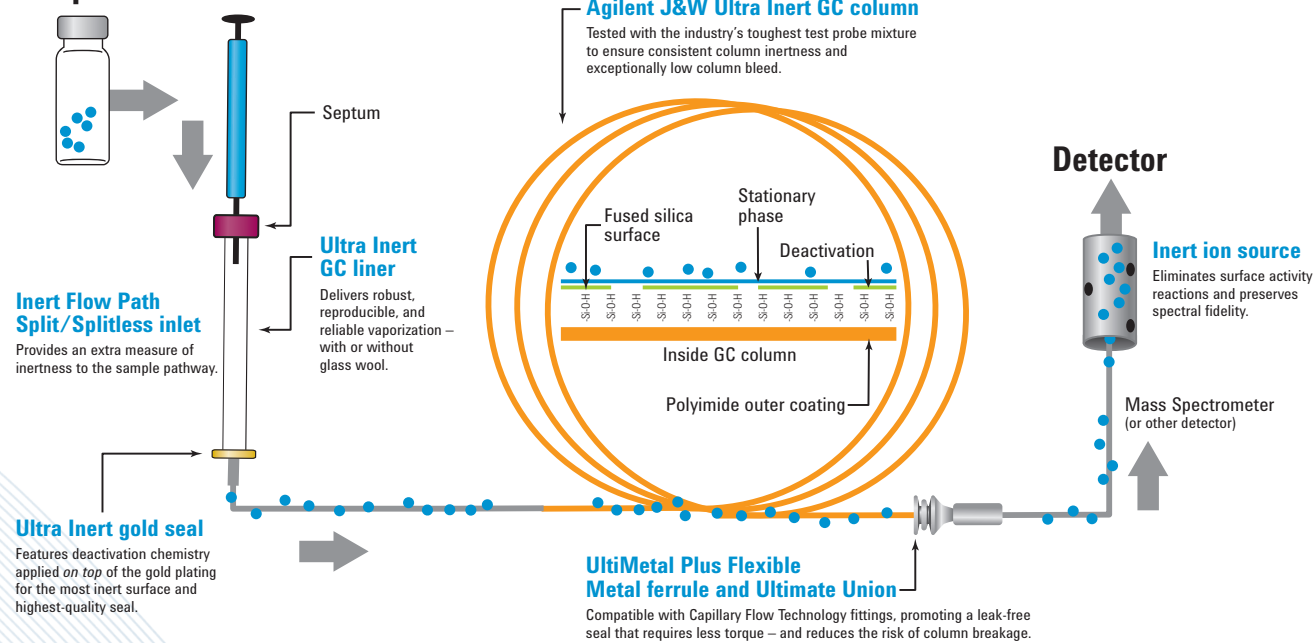

An integrated approach to inertness: The Agilent advantage

As the GC/MS industry's premier measurement company, Agilent is uniquely positioned to help ensure the inertness of every surface that touches your sample, so you can achieve the parts-per-billion – or parts-per-trillion – detection levels that today's analyses demand.

For more information about creating an inert GC flow path, visit agilent.com/chem/inert

PRODUCTIVITY ENHANCEMENTS

GREATER MS/MS SELECTIVITY, FASTER ANALYSIS

The increased selectivity provided by the MS/MS detection mode lessens the need for thorough chromatographic separation to deliver reliable qualitative and quantitative results. This leads to increased productivity, as the analysis can be accomplished in shorter times without sacrificing data quality.

For maximum productivity, the sensitivity of the 7010 allows uncompromised performance at the shortest (0.5 ms) dwell times, which means more analytes and shorter run times.

Shorter analysis time + MS/MS selectivity = PRODUCTIVITY

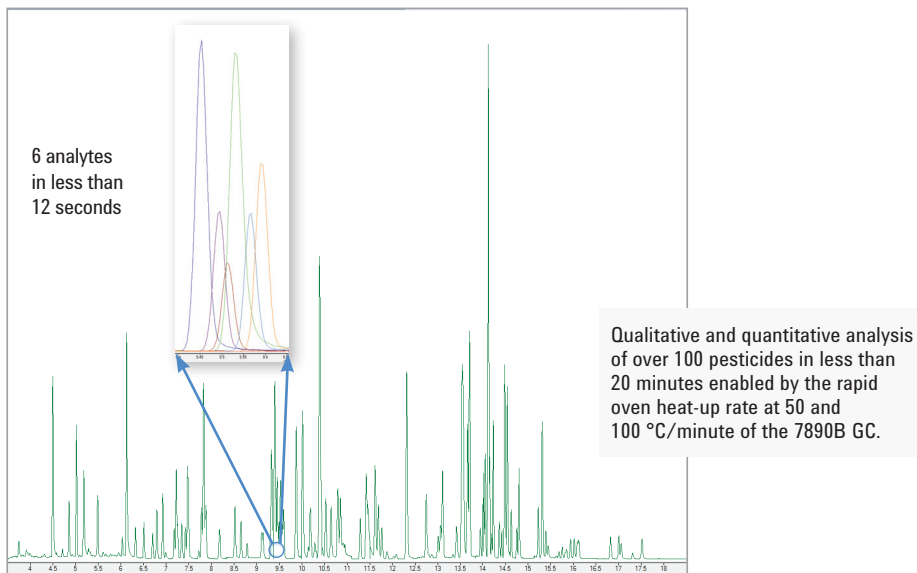

Take advantage of the 7890B GC's unmatched, fast oven heat-up rate to shorten analysis time, while the highly selective 7000C reduces the need for chromatographic separation.

The high selectivity of Agilent Triple Quadrupole detectors also allows you to use simple sample introduction devices, such as Agilent's Thermal Separation Probe (TSP). The TSP requires little or no sample preparation, allows easy control of sample delivery by temperature and split ratios, and eliminates contamination associated with direct sample probes. It can be used either with traditional columns or ultra-short 2 m columns for rapid sample delivery.

For more information, visit agilent.com/chem/TSP



GET ON THE FAST TRACK TO PRODUCTIVITY

Focus on system validation and data generation – not system configuration

Agilent GC/MS analyzers are factory configured and chemically tested to meet method requirements for food safety, environmental, and forensic/toxicology testing applications. These workflow solutions get you on the “Fast Track” to producing quality data and processing sample backlogs.

More than just instruments, Agilent analyzers are complete workflow solutions that incorporate advanced technologies, such as Capillary Flow Technology and target compound databases, which allow us to optimize your system for your unique application.

Each analyzer arrives ready to perform with pre-set chromatography and checkout samples to verify separation capabilities. That means your team can work toward system validation much sooner – and reduce method development costs by up to 80%. And as always, our support team is available should any problems arise.



Application-optimized columns and supplies



Application setup

Peak #	Compound Name	Area	Height	Width	Retention Time	Response	Area %	Height %	Width %	Retention Time (min)	Response (AU)
1	Acetone	1000000	100000	0.1	1.2	1000000	100	100	100	1.2	1000000
2	Acetic Acid	500000	50000	0.1	1.5	500000	50	50	50	1.5	500000
3	Acetic Anhydride	200000	20000	0.1	1.8	200000	20	20	20	1.8	200000
4	Acetic Chloride	100000	10000	0.1	2.1	100000	10	10	10	2.1	100000
5	Acetic Oxide	50000	5000	0.1	2.4	50000	5	5	5	2.4	50000
6	Acetic Sulfide	20000	2000	0.1	2.7	20000	2	2	2	2.7	20000
7	Acetic Tetroxide	10000	1000	0.1	3.0	10000	1	1	1	3.0	10000
8	Acetic Peroxide	5000	500	0.1	3.3	5000	0.5	0.5	0.5	3.3	5000
9	Acetic Dioxide	2000	200	0.1	3.6	2000	0.2	0.2	0.2	3.6	2000
10	Acetic Trioxide	1000	100	0.1	3.9	1000	0.1	0.1	0.1	3.9	1000
11	Acetic Tetraoxide	500	50	0.1	4.2	500	0.05	0.05	0.05	4.2	500
12	Acetic Pentaoxide	200	20	0.1	4.5	200	0.02	0.02	0.02	4.5	200
13	Acetic Hexaoxide	100	10	0.1	4.8	100	0.01	0.01	0.01	4.8	100
14	Acetic Heptaoxide	50	5	0.1	5.1	50	0.005	0.005	0.005	5.1	50
15	Acetic Octaoxide	20	2	0.1	5.4	20	0.002	0.002	0.002	5.4	20
16	Acetic Nonaoxide	10	1	0.1	5.7	10	0.001	0.001	0.001	5.7	10
17	Acetic Decaoxide	5	0.5	0.1	6.0	5	0.0005	0.0005	0.0005	6.0	5
18	Acetic Undecaoxide	2	0.2	0.1	6.3	2	0.0002	0.0002	0.0002	6.3	2
19	Acetic Dodecaoxide	1	0.1	0.1	6.6	1	0.0001	0.0001	0.0001	6.6	1
20	Acetic Tridecaoxide	0.5	0.05	0.1	6.9	0.5	0.00005	0.00005	0.00005	6.9	0.5
21	Acetic Tetradecaoxide	0.2	0.02	0.1	7.2	0.2	0.00002	0.00002	0.00002	7.2	0.2
22	Acetic Pentadecaoxide	0.1	0.01	0.1	7.5	0.1	0.00001	0.00001	0.00001	7.5	0.1
23	Acetic Hexadecaoxide	0.05	0.005	0.1	7.8	0.05	0.000005	0.000005	0.000005	7.8	0.05
24	Acetic Heptaedeaoxide	0.02	0.002	0.1	8.1	0.02	0.000002	0.000002	0.000002	8.1	0.02
25	Acetic Octadecaoxide	0.01	0.001	0.1	8.4	0.01	0.000001	0.000001	0.000001	8.4	0.01

Customized reporting



Training and consulting

The broadest portfolio of samplers

Agilent’s 7890B GC supports all of your sample introduction needs with a wide range of devices for liquids, headspace, purge-and-trap, gases – and even solids.



PAL Autosampler



Agilent 7693A Series Automatic Liquid Sampler



Agilent 7693 Automatic Liquid Sampler (ALS)

Our catalog of new applications is ever growing.

To learn more about the Agilent Triple Quadrupole GC/MS systems, visit us online at agilent.com/chem/ms

Learn more: agilent.com/chem

Buy online: agilent.com/chem/store

Find an Agilent customer center in your country: agilent.com/chem/contactus

U.S. and Canada
1-800-227-9770
option 3, then option 3 again
agilent_inquiries@agilent.com

In other countries, please call your local Agilent Representative or Agilent Authorized Distributor – visit agilent.com/chem/contactus

The Agilent Triple Quadrupole GC/MS Systems **Unprecedented reliability, system intelligence, and limits of detection**

- **High-Efficiency EI, second-generation Extractor EI, and PCI/NCI ion sources** with uniform thermal profile deliver stable performance
- **MRM method generation** is efficient, yet easily customizable.
- **The Pesticides and Environmental Pollutants MRM Database** is the most comprehensive database providing pertinent MS/MS parameters.
- **Inert Flow Path solutions** create an inert sample path for higher sensitivity, accuracy, and reproducibility – especially at trace levels.
- **MassHunter software** streamlines your workflow from instrument tune to report generation.
- **Direct GC+MS communication** minimizes downtime while conserving power and gas.
- **Integrated parts database** makes it easy to find and order columns, parts, and supplies.
- **Early maintenance feedback** keeps the system performing at its best.
- **Eco-friendly features**, such as Sleep/Wake modes, conserve electricity and other resources.
- **Secure data storage, archival, and search** with OpenLAB ECM.
- **The Agilent CrossLab portfolio** of services, supplies and software is designed with innovations to drive insight and help your lab maximum uptime.

Agilent Value Promise

We guarantee you at least 10 years of instrument use from your date of purchase, or we will credit you with the residual value of the system toward an upgraded model.

This information is subject to change without notice.

© Agilent Technologies, Inc. 2015
Printed in the USA May 15, 2015
5991-5931EN



Agilent Technologies