

# SOPRANE II

## MULTI-INSTRUMENT SOFTWARE REFERENCE FOR THE MICROGC RANGE

### Simplicity and performance, both in the laboratory and in the process

The first generation of the Soprane software has been a success for several years in the world of MicroGC, chosen by the largest companies for its unmatched functionality and ease of use.

The new Soprane II allows you to control several instruments at the same time, such as the most widely used MicroGC models on the market : Agilent 990 and 490, 3000 series, Varian CP4900 and of course, the whole range of the MicroGC SRA Instruments analyzers.

Always perfectly adapted to the on-line analysis and the needs of the laboratory, SOPRANE II benefits from a modern and efficient graphical environment, giving efficiency and easier use.

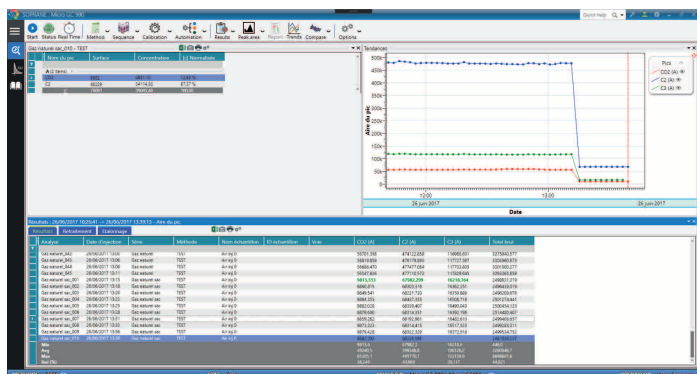

Main window of the software

### Process software

Soprane II is designed to meet the automation needs in process environment. It integrates the control of selection valves or isolation valves, pumps ... It ensures the supervision of the whole of the sampling, the analysis and the transmission of the results by triggering alarms at the slightest anomaly. It is also possible to integrate external sensor data (pressure, temperature, humidity, etc.) into the results.



### Powerful and multi-instrument software

Soprane II performs the complete management of an analysis, from the sampling to the transmission of the results. It includes a method creation module dedicated to MicroGC, a complete integrator easily set using interactive graphical tools. A chromatogram comparison module with curve display allows a quick visual analysis of the results. Specific calculation can be obtained: calorific value, Wobbe index, density ... Customized calculations can also be set.

Multi-instrument is also available, allowing control of several MicroGC at the same time.

## SOPRANE II

Clear results,  
Reliable values



Application fields :

- Process
- Chemical, pharmaceutical
- Research
- Biogas, biomass
- Coupling
- Etc.



▶ Easy to use



▶ Many Features



▶ Compatibility for all MicroGC



▶ Automating

# SOPRANE II

## TECHNICAL SPECIFICATIONS

### General specifications :

Windows Compatibility : Vista, Seven 32/64 bits, Windows 8, Windows 8.1 and Windows 10

MicroGC Compatibility : MicroGC Agilent 990 and 490, Varian CP4900, MicroGC 3000, all SRA Instruments MicroGC, ...

Multi-instrument : can control up to 4 instruments at the same time

### Sampling :

Stream selection : electro-valves, Valco valves, up to 135 streams

Piloting : auxiliary pump, mass flow meter

### Automating :

Sequence : schedule a sequence

Calibration : automatic multipoint calibration with average response coefficient for better accuracy

Bake out : automated column regeneration programming

### Methods :

Analyses : simple, dedicated MicroGC interface

Reprocess : integrator can be parameterized using graphic tools

### Analyses modes :

Multi-stream : definition of analysis sequences by channel and calibration

Launch of analyses : punctual, series of n analyses, sequence, continuous, calibration, control sample, at a given time, at a given frequency

### Specific calculations :

Natural gas : ISO 6976:2016, GPA 2261

LPG liquefied gases : ISO 8973, ISO 7941, ISO 6578

USP Pharmacopeia : USP Width, Signal to noise factor, Theoretical plates, Resolution

Others : combustion calculation, customized calculation

### Reporting results :

Results table : customized with normalization, unknowns, groups, calculation results

Visualization : several trend curves can be set for each channel (concentration of compounds, calculation results, ...)

Report : manual or automatic, customized, multi-format

### Data transmission :

Analog : 4-20mA, 0-1V, 0-10V

Digital : Modbus (RS232/485,TCP/IP), Labview, LIMS

External signal inputs : analog, logic, external start

### Alarms :

Types : configurable, general fault, compound alarm or concentration (raw, normalized, total, ...)

### Customization :

Windows service connectivity for automation, integration of external sources, client software interface

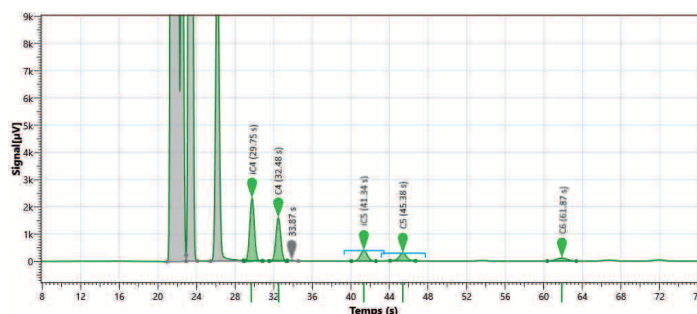

Process module Soprane II software

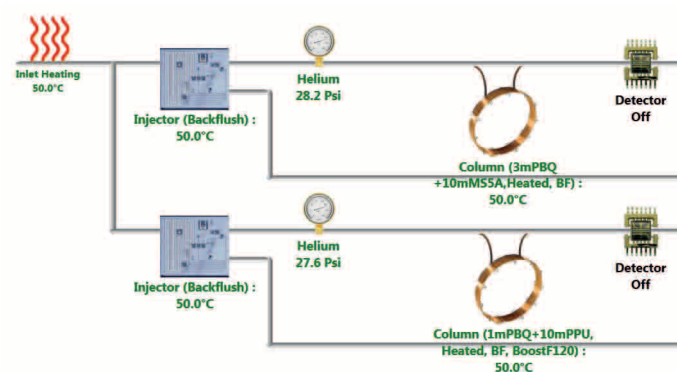

Instrument status display

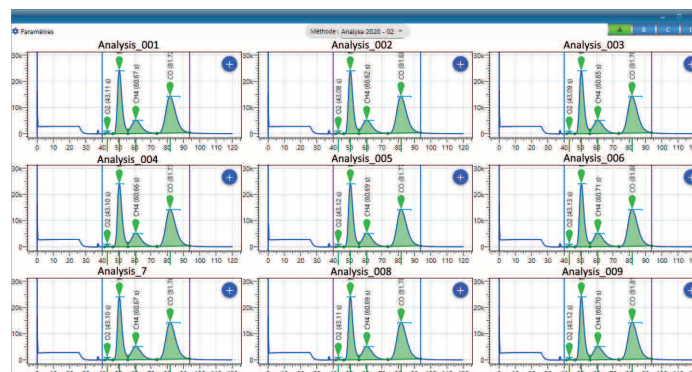

Compare module Soprane II software

Find us on [www.srainstruments.com](http://www.srainstruments.com)